

Buji ve Distribütör Terminalleri

Spark Plug and Distributor Terminals



Buji ve Distribütör Terminalleri

Spark Plug and Distributor Terminals

Ürün Tanımı	Ürün Kodu	Kablo Kesiti (mm ²)	Malzeme	K a p l a m a			Malzeme Kalınlığı (mm)	Standart Paketleme Miktarı (Adet)	
				Kaplamasız	Sn	Ni		Ag	Rulo
Description	Product Code	Wire Size (mm ²)	Material	P l a t i n g			Material Thickness (mm)	Standard Packing Quantity (Pieces)	
				Unplated	Sn	Ni		Ag	Chain
1555 RD-5	204000001	Ø 7	CuZn	Kalay Galvaniz			0.50	1000	1000

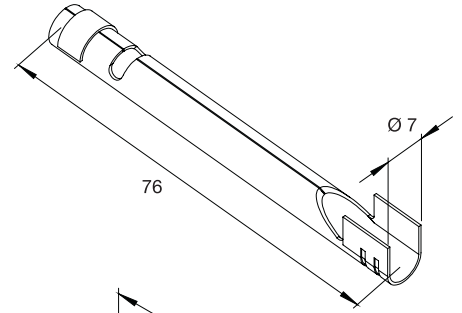

1580 FRUS	204000002	Ø 7- 8	CuSn	Paslanmaz			0.50	1000	2000
-----------	-----------	--------	------	-----------	--	--	------	------	------

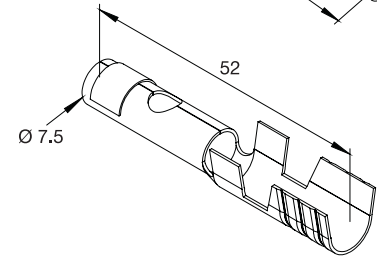

1540 SBW USD	204000003	Ø 7	CuZn				0.50	1000	2500
--------------	-----------	-----	------	--	--	--	------	------	------

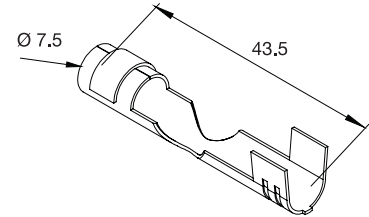

1568 SBW RJ-2	204000004	Ø 7	CuZn				0.50	1000	2500
---------------	-----------	-----	------	--	--	--	------	------	------

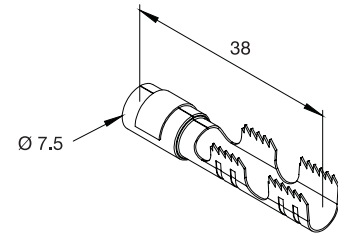

1401 SDW ÇT	204000005	Ø 7	CuZn	Kalay Galvaniz			0.50	1000	2500
-------------	-----------	-----	------	----------------	--	--	------	------	------

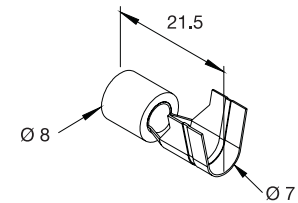

1404 SDW UST	201000006	Ø 7	CuZn	CuSn - Kalay			0.50	1000	2000
--------------	-----------	-----	------	--------------	--	--	------	------	------

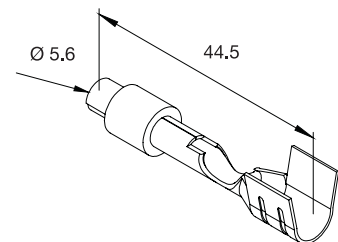

Buji ve Distribütör Terminalleri

Spark Plug and Distributor Terminals

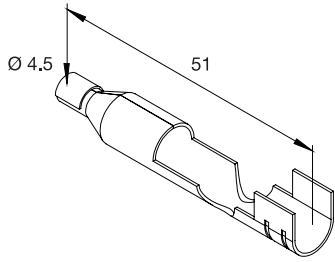

Ürün Tanımı	Ürün Kodu	Kablo Kesiti (mm ²)	Malzeme	K a p l a m a			Malzeme Kalınlığı (mm)	Standart Paketleme Miktarı (Adet)	
				Kaplamasız	Sn	Ni		Ag	Rulo
Description	Product Code	Wire Size (mm ²)	Material	P l a t i n g			Material Thickness (mm)	Standard Packing Quantity (Pieces)	
				Unplated	Sn	Ni		Ag	Chain
1410 PW	201000007	Ø 7	CuZn				0.50	-	1000

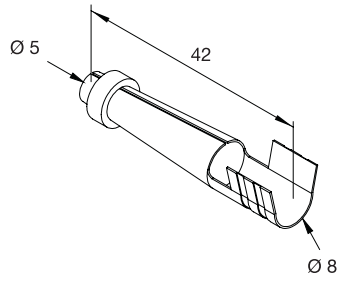

1408 SDW TSM	201000008	Ø 7	CuSn				0.50	-	2000
--------------	-----------	-----	------	--	--	--	------	---	------

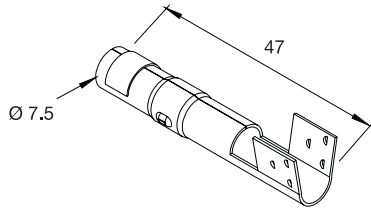

1550 RD-3	204000009	Ø 7- 8	St	Kalay Galvaniz			0.40	1000	2500
-----------	-----------	--------	----	----------------	--	--	------	------	------

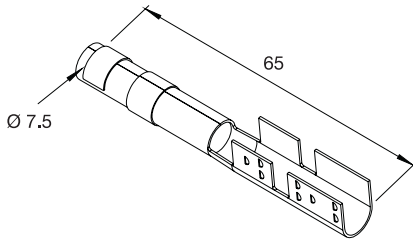

1554 RD-4	204000010	Ø 7- 8	St	Kalay Galvaniz			0.50	1000	2000
-----------	-----------	--------	----	----------------	--	--	------	------	------

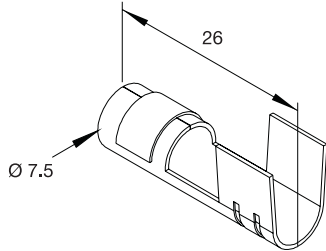

1549 SDW RD-1	204000011	Ø 8	CuSn	Kalay Galvaniz			0.50	1250	5000
---------------	-----------	-----	------	----------------	--	--	------	------	------

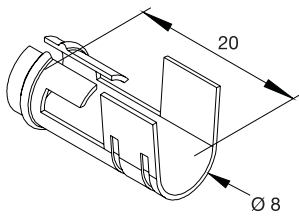

1563 SDW D-3 8 mm	201000101	Ø 7	CuSn				0.50	-	2000
-------------------	-----------	-----	------	--	--	--	------	---	------

Buji ve Distribütör Terminalleri

Spark Plug and Distributor Terminals

Ürün Tanımı	Ürün Kodu	Kablo Kesiti (mm ²)	Malzeme	K a p l a m a			Malzeme Kalınlığı (mm)	Standart Paketleme Miktarı (Adet)	
				Kaplamasız	Sn	Ni		Ag	Rulo
Description	Product Code	Wire Size (mm ²)	Material	P l a t i n g			Material Thickness (mm)	Standard Packing Quantity (Pieces)	
				Unplated	Sn	Ni		Ag	Chain
1558 SBW RD-6	204000102	Ø 7	CuSn	Kalay Galvaniz			0.50	1000	1000

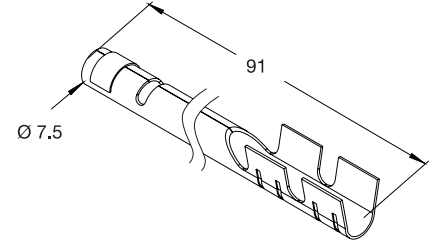

1561 SDWK	204000103	Ø 8	CuSn	Kalay Galvaniz			0.50	1250	5000
-----------	-----------	-----	------	----------------	--	--	------	------	------

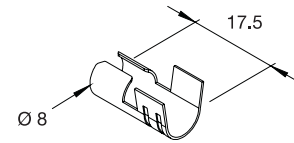

1542 USHK SDW JT	204000104	Ø 7-8	CuZn+St				0.50	-	2000
------------------	-----------	-------	---------	--	--	--	------	---	------

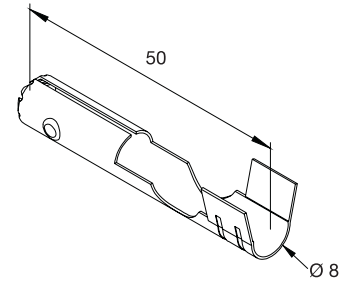

1400 SDW JT	205000105	Ø 5	St				0.40	-	2000
-------------	-----------	-----	----	--	--	--	------	---	------

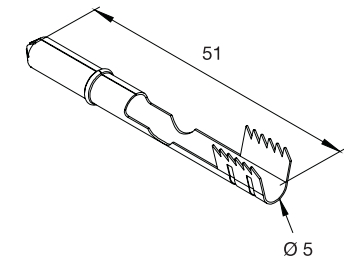

1543 USE 2	204000106	Ø 5	St				0.40	-	2000
------------	-----------	-----	----	--	--	--	------	---	------

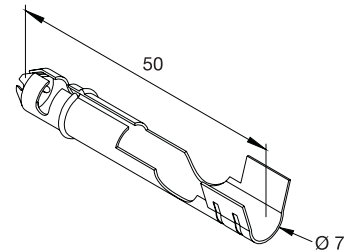

1451 SBW 90°	204000201	Ø 7	CuSn	■	□	□	□	0.50	750	2000
--------------	-----------	-----	------	---	---	---	---	------	-----	------

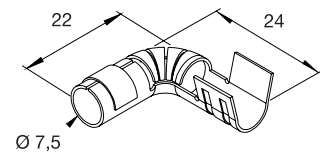

Buji ve Distribütör Terminalleri

Spark Plug and Distributor Terminals

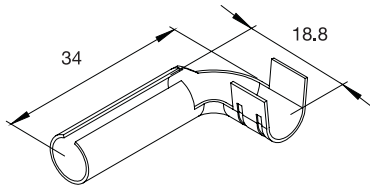
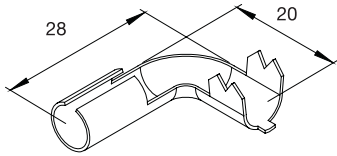
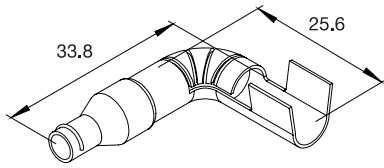
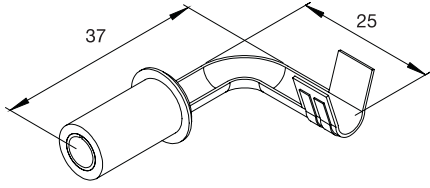

Ürün Tanımı	Ürün Kodu	Kablo Kesiti (mm ²)	Malzeme	K a p l a m a			Malzeme Kalınlığı (mm)	Standart Paketleme Miktarı (Adet)	
				Kaplamasız	Sn	Ni		Ag	Rulo
Description	Product Code	Wire Size (mm ²)	Material	P l a t i n g			Material Thickness (mm)	Standard Packing Quantity (Pieces)	
				Unplated	Sn	Ni		Ag	Chain
1402 SDW 90° ŞT	201000202	Ø 7- 8	CuZn		CuSn			600	2000

1412 USFR	201000203	Ø 7	CuZn		CuSn		0.50	-	2000
-----------	-----------	-----	------	--	------	--	------	---	------

1581 SDW 90° K	201000204	Ø 7	CuZn		Kalay Galvaniz		0.50	1000	2000
----------------	-----------	-----	------	--	----------------	--	------	------	------

1751 SDW 90°	204000205	Ø 7	CuZn		CuSn		0.50	-	2000
	201000205	Ø 7	CuZn		CuSn		0.50	-	2000